

# HEAT 2 BURNER GRILL 50 MBAR



## OWNERS MANUAL:

**USE OUTDOORS ONLY.**

Read the manual before using the bbq.

## WARNING:

Accessible parts may be very hot. Keep young children away.



# DANGER & WARNINGS

## DANGER

If you smell gas:

1. Shut off gas to the bbq
2. Extinguish any open flame
3. If odor continues keep away from the bbq and immediately call your gas supplier or your fire department.

Failure to follow these instructions could result in fire or explosion which could cause property damage, personal injury or death.

## DANGER

1. Never operate this bbq unattended.
2. Never operate this bbq within 10 feet(3.05 m) of any other gas bottle.
3. Never operate this bbq within 25 feet(7.5 m) of any flammable liquid.
4. Heated liquids remain at scalding temperatures long after the cooking process.
5. If a fire should occur, keep away from the bbq and immediately call your fire department. Do not attempt to extinguish an oil or grease fire with water.

Failure to follow these instructions could result in fire or explosion or burn hazard, which could cause property damage, personal injury or death.

Only persons who understand and follow the instructions should use or service this outdoor bbq.

## DANGER

### CARBON MONOXIDE HAZARD

- This bbq can produce carbon monoxide which has no odor.
- Using it in an enclosed space can kill you.
- Never use this bbq in an enclosed space such as a camper, tent, car, or home.

## CAUTION

- The use of alcohol, prescription or non-prescription drugs may impair your ability to properly assemble or safely operate the bbq.
- When cooking with oil/grease, fire extinguishing materials shall be readily accessible. In the event of an oil/grease fire, do not attempt to extinguish with water. Use Type BC dry chemical fire extinguisher or smother fire with dirt, sand or baking soda. Immediately call the fire department.
- In the event of rain or other forms of precipitation while cooking with oil/grease, cover the bbq immediately and turn off the bbq burners and gas supply. Do not attempt to move the bbq or bbq.
- When cooking, the bbq must be on a level, stable surface in an area clear of combustible material.
- Do not leave the bbq unattended. Keep children and pets away from the bbq at all times.
- Do not move the bbq when in use.
- This bbq is not intended for and should never be used as a heater.

This manual contains important information about the assembly, operation and maintenance of this outdoor propane/ butane bbq. General safety information is presented on this page and is also located throughout these instructions. Particular attention should be paid to information accompanied by the safety alert symbol

## DANGER WARNING CAUTION

Keep this manual for future reference and to educate new users of this product. This manual should be read in conjunction with the labeling on the product.

Safety precautions are essential when any mechanical or propane / butane fueled equipment is involved. These precautions are necessary when with the respect and caution demanded will reduce the possibilities of personal injury or property damage.

## DANGER

### EXPLOSION-FIRE HAZARD

- Never store propane/ butane near high heat, open flames, pilot lights, direct sunlight, other ignition sources or where temperatures exceed 120 degrees F (49°C).
- Propane/ butane gas is heavier than air and leaking propane / propane will sink to the lowest level possible. It can ignite by ignition sources including matches, lighters, sparks or open flames of any kind many feet away from the original leak. If you smell gas, leave the area immediately.
- Never install or remove propane / butane tank while outdoor bbq is lighted, near flame, pilot lights, other ignition sources or while outdoor bbq is too hot to touch.
- During operation, this product can be a source of ignition. Never use the bbq in spaces that contain or may contain volatile or airborne combustibles, or products such as gasoline, solvents, paint thinner, dust particles or unknown chemicals. Minimum distance from sides and back of unit to walls or railings is 12 inches (30.5 cm). Do not use under overhead unprotected combustible construction.
- Provide adequate clearances around air openings into the combustion chamber.
- DO NOT use gas bbq indoors or in garages, breezeways, sheds or enclosed areas.
- Do not obstruct the flow of combustion and ventilation air.

## WARNING

We cannot foresee every use which may be made of our products. **Check with your local fire safety authority if you have questions about use.**

Other standards govern the use of fuel gases and heat producing products for specific uses. Your local authorities can advise you about these.

- This bbq is not intended to be installed in or on recreational vehicles and/or boats.
- Do not alter parts sealed by manufacturer.
- Any modification of the bbq may be dangerous.
- Use protective gloves when handling particularly hot components.

# SERVICE SAFETY

## **!** DANGER

### CARBON MONOXIDE HAZARD

- This bbq is a combustion bbq. All combustion bbqs produce carbon monoxide (CO) during the combustion process. This product is designed to produce extremely minute, non-hazardous amounts of CO if used and maintained in accordance with all warnings and instructions. Do not block air flow into or out of the bbq.
- Carbon Monoxide (CO) poisoning produces flu-like symptoms, watery eyes, headaches, dizziness, fatigue and possibly death. You can not see it and you can not smell it. It's an invisible killer. If these symptoms are present during operation of this product get fresh air immediately!
- **For outdoor use only. If stored indoors, detach gas bottle outdoors.**
- **Never use inside house, camper, tent, vehicle or other unventilated or enclosed areas; this bbq consumes air (oxygen). Do not use in unventilated or enclosed areas to avoid endangering your life.**

## **!** WARNING

- This product is fueled by propane gas. Propane / butane gas is invisible, odorless, and flammable. An odorant is normally added to help detect leaks and can be described as a "rotten egg" smell. The odorant can fade over time so leaking gas is not always detectable by smell alone.
- Use only propane /butane gas set up for vapor withdrawal.
- Propane / butane gas should be stored or used in compliance with local ordinances.  
Turn off propane and disconnect gas bottle when not in use.
- Gas bottles must be stored out of reach of children.
- Only use gas bottles in upright position. Never use gas bottles in horizontal position.
- The gas pipe must be of a type that is approved in relation to national regulations and requirements and may never be more than 1.5 meters in length. The gas pipe should be renewed when national legislation requires this. If the gas bottle is placed outside the grill the gas pipe should be inserted through the hole in the base in order to ensure that it is not damaged in the door.

## **!** WARNING

### BURN HAZARD

- Never leave bbq unattended when hot or in use.
- Keep out of reach of children.

### VENTILATION

- Never turn on the grill with the lid closed.

## **!** DISCLAIMERS

- High temperature can and will affect corrosion-resistant steel to a give it a slightly darker shade. This condition cannot be reversed and is not covered by the guarantee.
- Scratches and other damage to the surface treatment will cause corrosion of the subjacent material. Such damage is not covered by the product guarantee. Seal any scratches and scrapes with heat-resistant lacquer stick or spray paint in the correct colour.
- Guarantee is given in accordance with local legislation.

- Keep all connections and fittings clean. Inspect propane /butane gas bottle and bbq propane / butane connections for damage before attaching.
- During set up, check all connections and fittings for leaks using soapy water. Never use a flame. Bubbles indicate a leak. Check that the connection is not cross-threaded and that it is tight. Perform another leak check. If there is still a leak, remove the gas bottle and contact your dealer for service or repairs.



- Use as a cooking bbq only.
- Clean bbq frequently to avoid grease accumulation and possible grease fires.

# SPECIFICATIONS

Model	Total Heat output	Total gas input	Injector size
HEAT 2 Burner	11,2 Kwh / 38.500 BTU	800 g/h	1,05 mm

For use in	Category	Supply pressure	
		Butane	Propane
D	I3B/P	50 mbar	50 mbar
AT	I3B/P	50 mbar	50 mbar
CH	I3B/P	50 mbar	50 mbar

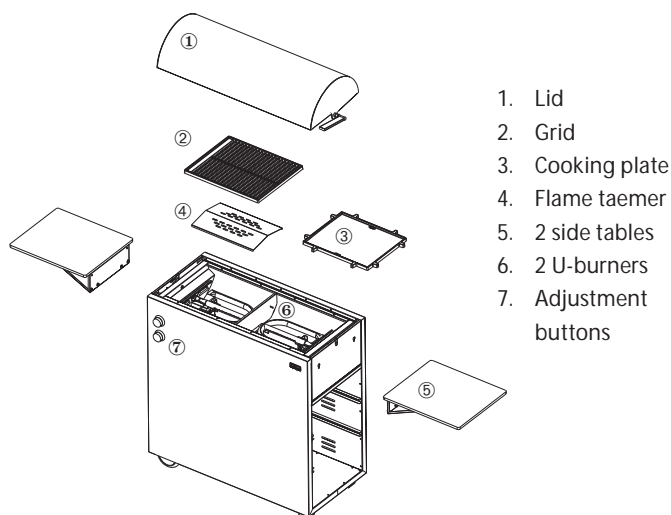

1. Lid
2. Grid
3. Cooking plate
4. Flame taemer
5. 2 side tables
6. 2 U-burners
7. Adjustment buttons

# GAS BOTTLE

Gas bottles up to and including the 15 kg size may be used. Do not use gas bottles larger than 15 kg. The grill can be mounted with a 5 kg gas cylinder at the bottom part of the grill as shown in this manual. Cylinders larger than 5kg are placed beside the bbq.

Always treat a gas bottle with care. Never store it on its side because the valve could become damaged, resulting in a leak which could be serious. Always use the gas bottle upright. Horizontally, liquid fuel could get into the supply pipes with damaging results.

Always place the gas bottle in an accessible location to facilitate changing and emergency shut off. Always disconnect the gas bottle before moving the bbq.

Never subject a gas bottle to heat. The pressure inside the gas bottle could build up and exceed the designed safety limit.

Never store gas bottles in cellars, adjacent to open drains and basement areas or below ground level. Propane is heavier than air. If there is a leak, the gas will collect at low level and become dangerous in the presence of a spark or flame.

Never store butane or propane gas bottles indoors.

## STORAGE

Please be aware that insects and spiders often nest inside the bbq and could alter and obstruct the gas flow and cause failure and safety hazards.

Please see cleaning procedure in general and in specific the procedure for cleaning burner pipe.

## SERVICING

This gas bbq should not be altered or interfered with, (except for burner flame adjustment as directed in the instructions). Any adjustment or servicing should be carried out by a qualified engineer. Regular maintenance is recommended. See maintenance instructions.

# INSTALLATION

## SET UP

Remove the components from the carton (Fig. 1)

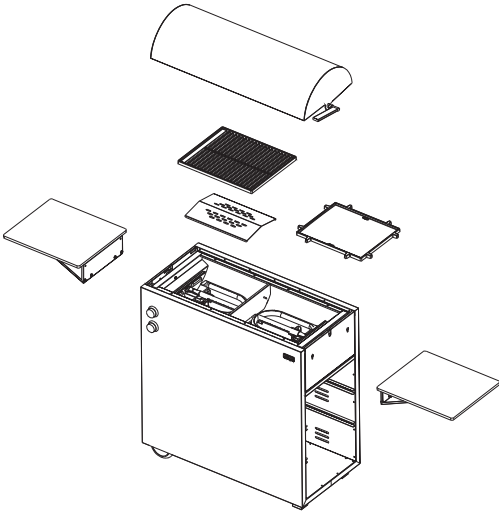

Install grease tray and mount flame tamer (Fig. 2)



Install grid (Fig. 3)



Install cooking plate (Fig. 4)

The gas pipe must be of a type that is approved in relation to national regulations and requirements and may never be more than 1.5 meters in length. The gas pipe should be renewed when national legislation requires this (Fig. 5)



Assemble the gas hose on the pre-assembled pipe connection or the 1/4 link thread (Fig. 6)

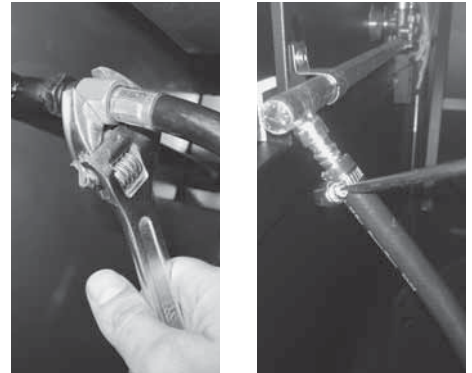

The lid is operated by the rotary handle at the right side. Be careful not to have your fingers stuck when turning the handle. (Fig. 7)

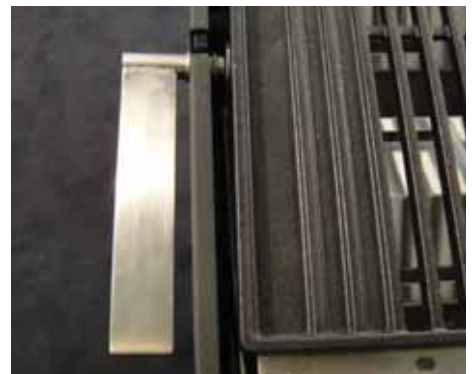

# CHANGING A GAS BOTTLE – BUTANE

This bbq may be used with butane at an operating pressure of 28 - 30 mbar.

**NEVER** use an unregulated gas supply or a regulator for other operating pressures.

**WARNING:** Changing a gas bottle must be carried out in a flame free environment.

BUTANE gas bottles have various types of connections.

Leak test all connections **before** operating the bbq.

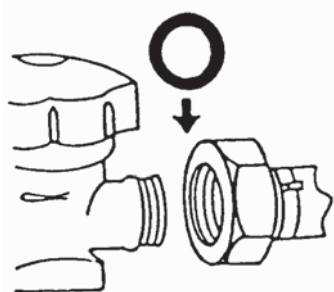

## A) SCREW-ON CONNECTION.



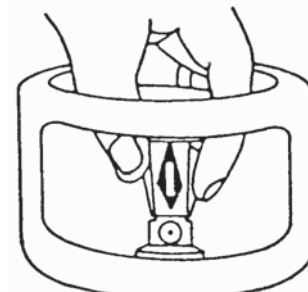



The most important part is the black sealing washer. Always check that it is present and not damaged when changing gas bottles. Some screw on connections have a hand wheel to tighten and some require a spanner to tighten. Tighten firmly (left hand thread). When using a spanner, do not over tighten as this can damage the washer.



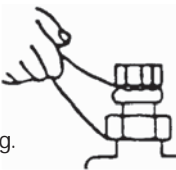

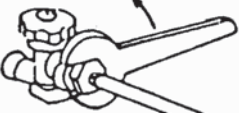

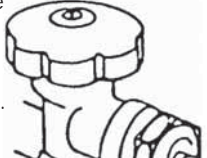

## B) SWITCH-ON CONNECTION.

No tools are required for this type. On/Off control of the gas supply is provided by a switch on the Regulator or on a special adapter. If you use an adapter with an old type threaded regulator, please ensure that the union nut is tightened firmly to the adapter with a spanner.

### CONNECTING A GAS BOTTLE

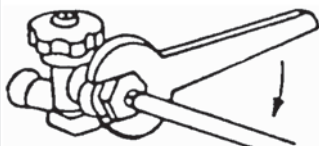
Screw-om connection	Switch-om connection
<p>1. Check that the gas bottle valve is OFF by turning clockwise.</p>	<p>1. Remove the orange safety cap by pulling the lanyard out, then up. Do not use tools, leave the cap hanging.</p> 
<p>2. Remove protective cap and keep for later use.</p> <p>3. Inspect the black washer for damage before connecting.</p> 	<p>2. Make sure that:</p> <ul style="list-style-type: none"> <li>– All taps on the gas bbq are closed.</li> <li>– The switch is in the off position.</li> </ul> 
<p>4. Fit the connecting nut to the gas bottle, using the correct spanner or connecting hand wheel. (Left hand thread). Do not over tighten Butane gas bottle connectors.</p> 	<p>3. Place the "Quick On" regulator on to the valve and push down firmly. A "click" sound should be heard to ensure the switch is securely latched.</p> 
<p>5. When gas is required turn the gas bottle valve anti-clockwise.</p> 	<p>4. When gas is required turn the switch upward to the ON (12 o'clock) position.</p> 

### DISCONNECTING A GAS BOTTLE

Screw-om connection	Switch-om connection
<p>1. Turn the gas bottle valve OFF (Clockwise rotation).</p> 	<p>1. Turn the switch to the OFF (3 o'clock) position.</p> 
<p>2. Turn off the gas taps on the bbq. WAIT until the burner has gone out. IF THE FLAME DOES NOT GO OUT-TURN THE VALVE OR SWITCH BACK TO ON. LEAVE THE APPLIANCE ALIGHT AND CALL YOUR GAS SUPPLIER.</p>	<p>2. NEVER REMOVE the regulator (or connecting nut) with the gas bottle valve open.</p>
<p>3. NEVER REMOVE the regulator (or connecting nut) with the gas bottle valve open.</p> <p>4. REMOVE the regulator (or connecting nut) with the spanner or connecting hand wheel. (Left hand thread).</p> 	<p>3. Remove the "Quick On" regulator by pressing horizontally on the switch and pulling upwards at the same time.</p> 
<p>4. REPLACE the plug or cap onto the empty gas bottle or part full cylinder if not in use.</p> 	<p>4. REPLACE the seal cap onto the empty cylinder, or part full gas bottle if not in use.</p> 

# CHANGING A GAS BOTTLE – PROPANE

This bbq may be used with propane at an operating pressure of 30-37 mbar.

**NEVER** use an unregulated gas supply or a regulator for other operating pressures.

**WARNING:** Changing a gas bottle must be carried out in a flame free environment.

Propane gas bottles have various types of connections. If a sealing washer is used in the connection, check that it is present and not damaged when changing gas bottles. Some connectors have a handwheel to tighten and some require a spanner to tighten. Always use the correct size spanner and fully tighten, (left hand thread).

Leak test all connections **before** operating the bbq.

## CONNECTING A GAS BOTTLE

1. Check that the gas bottle valve is OFF by turning clockwise.  
Remove protective plug and keep to replace later.

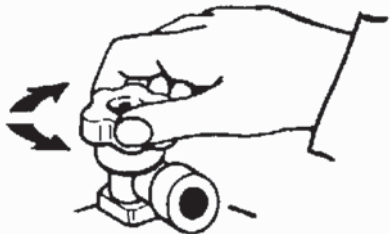

2. Inspect the connection for damage before connecting.  
Fit the connecting nut (left hand thread) to the gas bottle.
  - a. **Connecting Nut for use with Spanner** – Using the correct spanner, tighten the connecting nut as tight as possible.

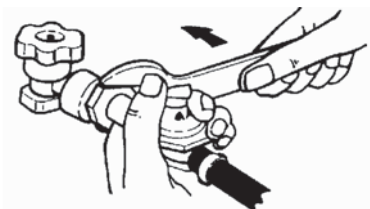

- b. **Handwheel Connecting Nut** – Using hand pressure, tighten the connecting nut firmly. Do not use a spanner on a hand-wheel connection.

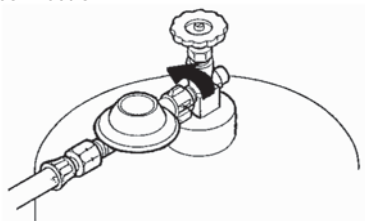

After fitting the regulator it may have assumed a position out of the horizontal, this is not important, **DO NOT TWIST THE REGULATOR.**

3. When gas is required, turn the gas bottle valve anti-clockwise.

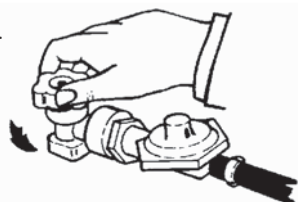

## DISCONNECTING A GAS BOTTLE

1. Turn the gas bottle valve OFF (clockwise rotation). Check that the burner flame has gone out.

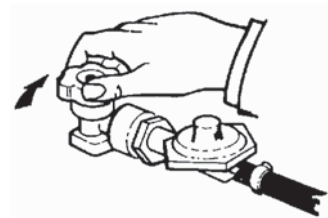

2. Remove the Regulator connecting nut (left hand thread) with spanner or handwheel. Replace protective plug into valve outlet. Place empty gas bottle in a safe place.

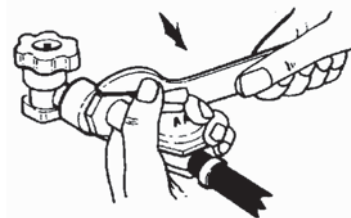

# LEAK TESTING

All factory-made connections have been thoroughly tested for gas leaks and the burners have been flame tested. However, shipping and handling may have loosened a gas fitting.

## AS A SAFETY PRECAUTION:

- **TEST ALL FITTINGS FOR LEAKS BEFORE USING YOUR GAS BARBECUE.**
- **TEST THE GAS BOTTLE VALVE FOR LEAKS EACH TIME THE GAS BOTTLE IS FILLED.**

## WARNING

- Perform leak test outdoors.
- Extinguish all open flames.
- NEVER leak test when smoking.
- Do not use the outdoor bbq until connection is tested and found safe.



## TO TEST FOR LEAKS

1. Connect the flexible tube and regulator to a **full** gas bottle.
2. Check that all control knobs are turned to "OFF".
3. Prepare a soap solution of one part water, one part liquid detergent.
4. Open gas bottle valve all the way.
5. Brush the soap solution on each connection.
6. A leak is identified by a flow of bubbles from the area of the leak.
7. If a leak is detected, close the gas bottle "shut-off" valve, tighten the connection and retest.
8. If the leak persists, contact your barbecue dealer for assistance. Do not attempt to operate bbq if a leak is present.

# ELECTRONIC LIGHTING SYSTEM

- Before use open battery compartment in the bottom of the bbq and insert a AA/LR6 battery 1,5 V.  
Open the door at the right side of the bbq.  
Open the battery door mounted on the rear side of adjusting buttons and insert the battery.
- Close battery compartment.
- To light bbq push knob and turn knob counter clockwise onto symbol. 
- Keep knob pushed in until flames are stabil and the thermo safety device is hot enough to maintain gas flow.
- Please note that while knob is pushed in the clicking sound from the electronic lightning device is normal.

When thermo safety device has switched on turn knob to high

or low setting and you are ready to bbq.



# LIGHTING

The bbq will be hot during and after use. Use insulated oven mitts or gloves for protection from hot surfaces or splatter from cooking liquids.

- **NEVER LEAVE GRILL UNATTENDED WHEN HOT OR IN USE.**
- **KEEP OUT OF REACH OF CHILDREN.**
- **NEVER TURN ON THE GRILL WITH THE LID CLOSED**
- **THE LID GETS VERY HOT, BOTH WHEN IT IS CLOSED AND OPEN. TAKE CARE NOT TO TOUCH THE LID. TAKE SPECIAL CARE WHEN THE LID IS OPEN AND YOU WANT TO TURN THE BUTTON FOR ADJUSTING THE GAS.**
- **WHEN YOU USE THE GRILL FOR THE FIRST TIME, LET IT BE ON FOR 5 MINUTES WITH THE LID OPEN AND THEN FOR 10 MINUTES WITH THE LID CLOSED AT THE HIGHEST TEMPERATURE SETTING. THIS WILL REMOVE ANY POSSIBLE RESIDUES FROM THE CONSTRUCTION. AT THIS STAGE SMELL AND SMOKE MAY OCCUR.**

Fig. 1

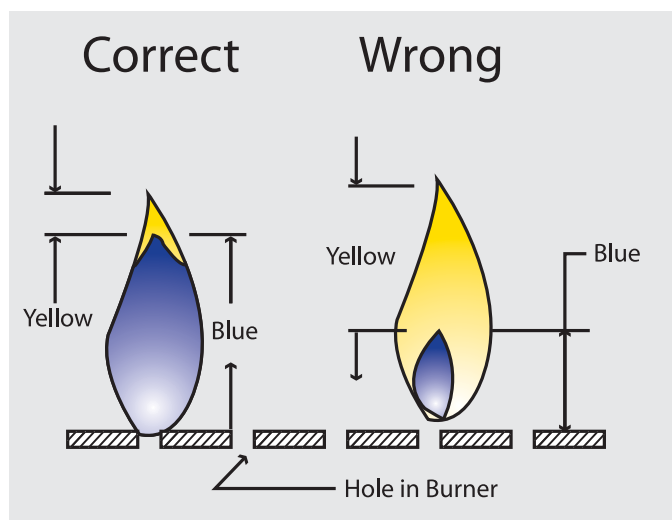



# COOKING

The grill comprises 2 powerful U-burners.

The U-burners is adjusted by means of the setting button at an interval of about 100 - 350°C.

The best result is obtained when meat is prepared by closing pores by using high temperature. This means that the grill is to be set at the highest temperature and after 5 to 10 minutes it will have the maximum temperature. You can use the grill with the lid fully open, half way open, one quarter open and closed.

Please note that the grill gets easily too hot when the lid is one quarter open or closed. The grill should always be under supervision when the lid is in one of these positions. Only use the grill at low temperature when used for indirect grilling with the lid closed.

Close the lid of the grill by inserting the split-pin in the frame and into the relevant opening in the lid. This function is also used for locking the lid when the grill is to be moved.

When the lid is one quarter open you can supervise the cooking, when the temperature is always as high as with the lid closed  
When the lid is half open, it functions as a wind shield

Please note that the indications of the thermometer are approximate and that they should always be checked by keeping an eye on the grill and the food to be prepared.

☞ See Figure 1 page 8:

## CORRECT GAS FLAME:

A good flame should be blue with minimal yellow tip. Some yellow tips on flames are acceptable as long as no carbon or soot deposits appear.

If flames do not comply with below picture clean burner pipes and try again.

If this does not correct the problem please contact your dealer.

Note: Yellow flame for the first 2 min. is considered normal.

# MAINTENANCE

## TO CLEAN

- Make sure grill is cold.
- Detach regulator from gas bottle.
- Wipe clean with soft cloth and mild dish detergent.  
Do not use abrasives.



## CLEANING OF PIPE BURNERS

To clean pipe burners loosen connection at burner pipe and detach pipe. Clean outside of pipe with cloth and inside with a bottle cleaner.

When done attach burner pipe and fasten connection.  
After cleaning always perform leak test.



The grid is made of cast iron and may corrode. If the grid corrodes, it should be treated with cooking oil. We recommend that you leave the grid after use without cleaning it and clean it prior to the next use. In this way you reduce the risk that the grid corrodes.

Surfaces of stainless steel shall be cleaned with detergents made particularly for cleaning of stainless steel. Painted surfaces should be cleaned with a mild detergent and a damp cloth.

# TROUBLE SHOOTING

Problem	Possible cause	Corrective action
<b>SMELL OF GAS</b>	<b>SHUT OFF LP GAS BOTTLE VALVE AT ONCE. DO NOT USE THE APPLIANCE UNTIL LEAK IS SEALED.</b>	
Leak detected at gas bottle, regulator or other connection.	<ol style="list-style-type: none"> <li>1. Regulator fitting loose.</li> <li>2. Gas leak in hose/regulator or control valves.</li> </ol>	<ol style="list-style-type: none"> <li>1. Tighten fitting and "Leak Test"</li> <li>2. See authorized service centre.</li> </ol>
Flame flashback beneath control panel.	<ol style="list-style-type: none"> <li>1. Pipe Burner blocked.</li> </ol>	<ol style="list-style-type: none"> <li>1. Remove burner, clean burner pipe. See "Cleaning of Pipe Burners"</li> </ol>
Burner will not light.	<ol style="list-style-type: none"> <li>1. Out of Gas.</li> <li>2. Ignitor wire(s) not connected.</li> <li>3. Ignitor electrode misaligned on burner.</li> <li>4. Ignitor malfunction.</li> <li>5. Regulator is not fully connected to the gas bottle valve.</li> <li>6. Burner valve left open while gas bottle valve was opened causing excess flow device to activate.</li> <li>7. A leak in the system causing the excess flow device to activate.</li> <li>8. Pipe Burner blocked.</li> <li>9. Pipe Burner not aligned with valve orifice.</li> <li>10. Orifice blocked.</li> <li>11. Hose is twisted.</li> </ol>	<ol style="list-style-type: none"> <li>1. Refill Gas bottle.</li> <li>2. Connect electrode wires.</li> <li>3. Realign electrode.</li> <li>4. Use "Manual Lighting" Procedure.</li> <li>5. Tighten the regulator hand wheel.</li> <li>6. Close burner and gas bottle valves. Open gas bottle valve slowly, then open burner valve to light.</li> <li>7. Leak test connections to determine loose fitting. Tighten fitting. Leak test system.</li> <li>8. Remove burner, clean Pipe Burner. See "Cleaning of Pipe Burners"</li> <li>9. Realign Pipe Burner to orifice. See "Cleaning of Pipe Burners"</li> <li>10. Remove burner, clean orifice with a pin or fine wire. Do not attempt to drill orifice.</li> <li>11. Straighten hose.</li> </ol>
Decreasing heat, "popping sound"	<ol style="list-style-type: none"> <li>1. Out of Gas.</li> <li>2. Pipe Burner blocked.</li> </ol>	<ol style="list-style-type: none"> <li>1. Refill Gas bottle.</li> <li>2. Remove burner, clean Pipe Burner. See "Cleaning of Pipe Burners"</li> </ol>
Hot spots on cooking surface.	<ol style="list-style-type: none"> <li>1. Pipe Burner blocked.</li> </ol>	<ol style="list-style-type: none"> <li>1. Remove burner, clean Pipe Burner. See "Cleaning of Pipe Burners"</li> </ol>
"Flare-ups" or grease fires.	<ol style="list-style-type: none"> <li>1. Excessive grease buildup.</li> <li>2. Excessive heat.</li> </ol>	<ol style="list-style-type: none"> <li>1. See "Maintenance"</li> <li>2. Turn burner controls to a lower setting.</li> </ol>
Humming noise from regulator.	<ol style="list-style-type: none"> <li>1. Gas bottle valve turned on too quickly.</li> </ol>	<ol style="list-style-type: none"> <li>1. Turn gas bottle valve on slowly.</li> </ol>
Yellow Flame.	<ol style="list-style-type: none"> <li>1. Some yellow flame is normal. If it becomes excessive the Pipe Burner may be blocked.</li> <li>2. Burner ports blocked.</li> </ol>	<ol style="list-style-type: none"> <li>1. Remove burner, clean Pipe Burner. See "Cleaning of Pipe Burners"</li> <li>2. Remove burner &amp; clean with soft bristle brush.</li> </ol>

# OTHER PRODUCTS BY



Table BBQ ▲



Walmounted gas heater ▲



Firepit ▲



Mini Cube ▲



4 Burner BBQ ▲



3 Burner BBQ ▲



HEAT R Charcoal ▲



Cube 53 BBQ ▲



HEAT cover for 4 burner BBQ ▲



HEAT Cover for Walmounted gas heater ▲



HEAT cover for Table BBQ ▲



HEAT cover for gasbottle ▲



HEAT cover for gasbottle ▲

**WARNING:**

Accessible parts may be very hot. Keep young children away. Use outdoors only. Read the instructions before using the appliance.

**ACHTUNG:**

Teile des Gerätes können bei Gebrauch sehr heiss werden. Vorsicht mit Kindern. Nur im Freien zu verwenden. Unbedingt Gebrauchsanleitung vor Inbetriebnahme beachten.

**ADVARSEL:**

De tilgængelige dele kan være meget varme. Hold derfor små børn på afstand. Må kun benyttes udendørs. Læs brugsvejledningen før brug.

**OPGELET:**

Onderdelen kunnen bij gebruik erg heet worden. Kinderen op afstand houden. Alleen voor gebruik buitenshuis. Lees de gebruiksaanwijzing alvorens het toestel te gebruiken.

**ATTENTION!**

Les pièces accessibles peuvent être très chaudes. Tenez les enfants à distance. N'utilisez l'appareil qu'à l'extérieur. Lisez les instructions attentivement avant l'utilisation.

**ADVERTENCIA:**

Las piezas accesibles pueden estar muy calientes. Mantenga alejados a los niños pequeños. Sólo para uso al aire libre. Lea estas instrucciones antes de usar la barbacoa.